

ROTISSERIE

SPECIFICATIONS

Model : **MAG 58/8** Gas Version

Manufacturer :



DESIGN

Traditional Rotisserie with powerful lighting system.
Porcelain Enamel finish with choice of color available.
Decorative roof with lighted rotisserie sign.

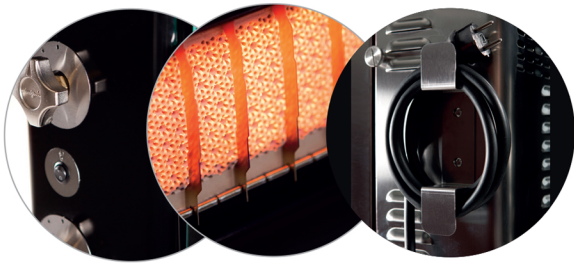

COOKING SYSTEM

8 spits.
Each individual spit has its own unique burner for a constant and fast cooking time.
Adjustable spits allow to cook any type of products from chicken to turkey, lamb, beef and vegetables.
A variety of attachments are also available such as basket spits and chicken spits.
Our rotisserie ingenious spit adjustment guarantees a perfect cooking regardless of the size of the product.
Individual motors.
Manual pilots.

CLEANING

Easy to clean and safe to maintain.
Removable back / burner panels.
Splash guard for each burner.
Removable burner panels, rounded corners.
Drain valve.



PERFORMANCE

Porcelain enamel finish and individual burners provide the best cooking system for poultry.
Fast and consistent from 48 to 56 chickens capacity in less than an hour.
The unique individual burner system provides exceptional control and unmatched durability.
The porcelain enamel guarantees a non stick, most durable surface.
Patented prong-less spits.
Enameled burner panels.

COLORS

STANDARD	OPTIONS
■ Signal Black (RAL 9004)	■ Purple Red (RAL 3004)
	■ Traffic Red (RAL 3016)
	■ Gentian Blue (RAL 5010)
	■ Stainless Steel



ROTISSERIE SPECIFICATIONS

Model : **MAG 58/8** Gas Version

Manufacturer :



TOP VIEW

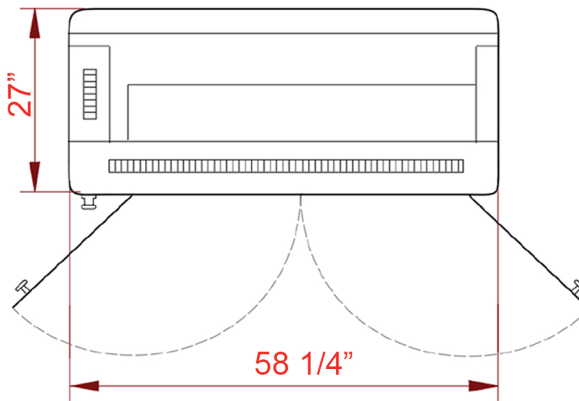

SIDE VIEW

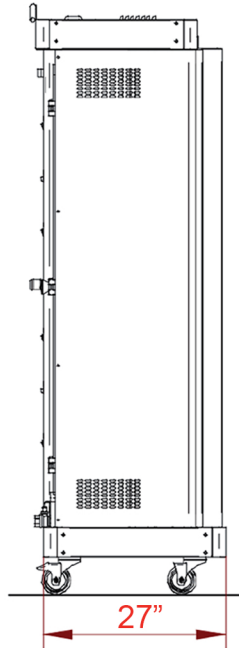

FRONT VIEW

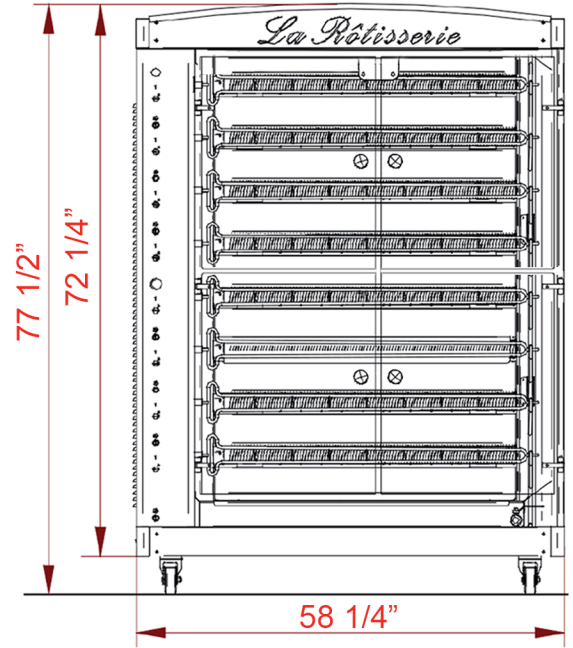

G	3/4" Gas Connector
E	5.0 Amps, 208/220 V Single Phase



Gas Consumption	195,000 BT/hr (Natural gas) 177,000 BTH/hr (Propane)	STANDARD FEATURES
Gas Min. Pressure	7" W.C (Natural gas) 11" W.C (Propane)	STD finish : Black Enamel with all Stainless steel trims
Gas Connector	3/4"	8 spits
Electricity	5.0 Amps, 208/220 V Single Phase	Bottom drip pan with drain valve
Capacity	Up to 48 with 3lbs Chicken Up to 56 with 2lbs Chicken	4 Tempered glass doors
Warranty	1 Year parts and labor	4 casters with front brakes
Venting	The rotisserie requires a type 1 grease type hood installed in accordance with all national and local codes	Manual Pilots and Individual Motors
Min. Clearance	6" on the right, left and rear side	Roof with Lighted Rotisserie Sign
Shipping Weight	750 lbs crated	208 / 220 V Single Phase