

ROTISSERIE

SPECIFICATIONS

Model : **MAG 40/4 S** Gas Version

Manufacturer :



DESIGN

Stainless Steel design with powerful lighting system.
Glass-ceramic protected quartz lighting.

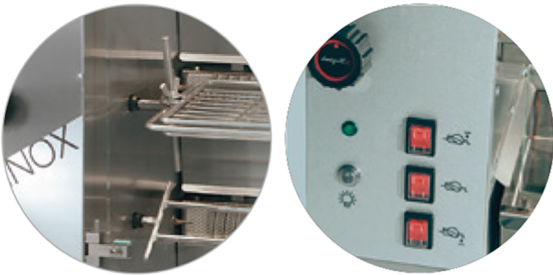

COOKING SYSTEM

4 spits 3 burners.

Adjustable spits allow to cook any type of products from chicken to turkey, lamb, beef and vegetables.

A variety of attachments are also available such as basket spits and chicken spits.

Our rotisserie ingenious spit adjustment guarantees a perfect cooking regardless of the size of the product.

Individual motors.

Manual pilots.

CLEANING

Easy to clean and safe to maintain.

Splash guard for each burner.

Removable burner panels.

Drain valve.



PERFORMANCE

Fast and consistent from 12 to 16 chickens capacity in less than an hour.

The unique individual burner system provides exceptional control and unmatched durability.

Patented prong-less spits.

Stainless Steel burner panels.

COLORS

STANDARD

■ Signal Black
(RAL 9004)

OPTIONS

■ Purple Red (RAL 3004)
■ Traffic Red (RAL 3016)
■ Gentian Blue (RAL 5010)
■ Stainless Steel



ROTISSERIE SPECIFICATIONS

Model : **MAG 40/4 S** Gas Version

Manufacturer :



TOP VIEW

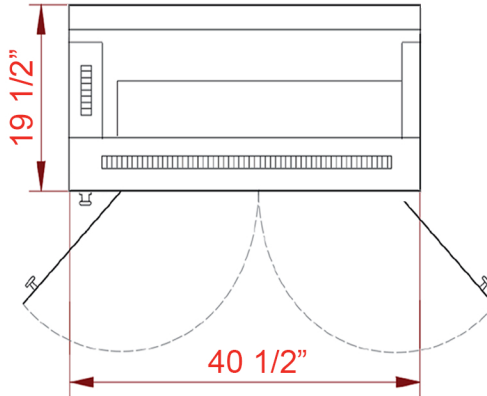

SIDE VIEW

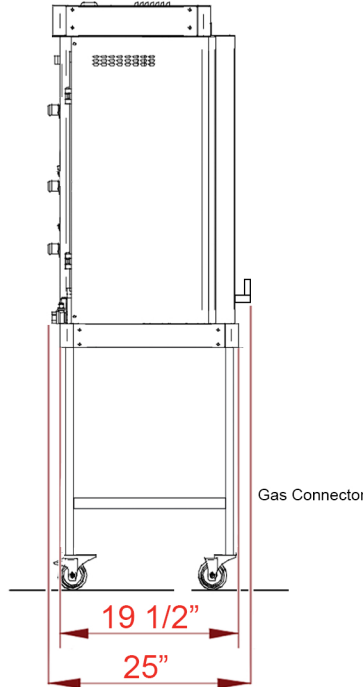

FRONT VIEW

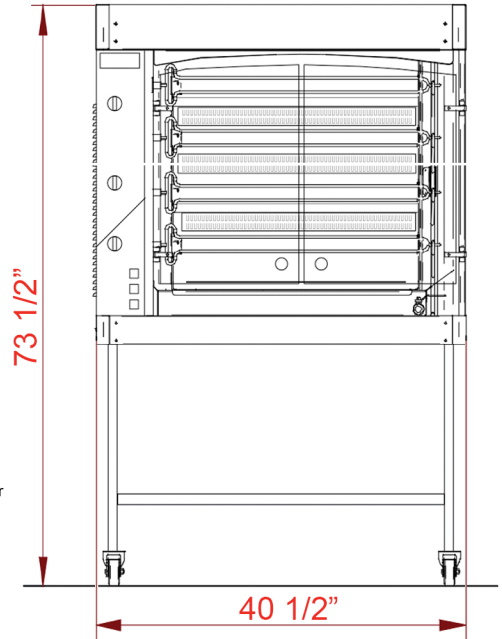

G	3/4" NPT Male Connection, 61 1/8" AFF
E	4.0 Amps, 208/220 V Single Phase



Gas Consumption	90,000 BT/hr (Natural gas) 80,000 BTH/hr (Propane)	STANDARD FEATURES
Gas Min. Pressure	7" W.C (Natural gas) 11" W.C (Propane)	STD finish : Stainless steel with all Stainless steel trims
Gas Connector	3/4"	4 spits
Electricity	4.0 Amps, 208/220 V Single Phase	Bottom drip pan with drain valve
Capacity	Up to 12 with 3lbs Chicken Up to 16 with 2lbs Chicken	2 Tempered glass doors
Warranty	1 Year parts and labor	4 casters with front brakes
Venting	The rotisserie requires a type 1 grease type hood installed in accordance with all national and local codes	Manual Pilots and Individual Motors
Min. Clearance	6" on the right, left and rear side	208 / 220 V Single Phase
Shipping Weight	420 lbs crated	