

1515 Design

BASKET-ROAST ROTISSERIES ACCESSORIES



CATALOG 2023

WWW.1515DESIGN.COM
Made in France

BASKET -ROAST ROTISSERIES ACCESSORIES

ACCESSORIES

Manufacturer :

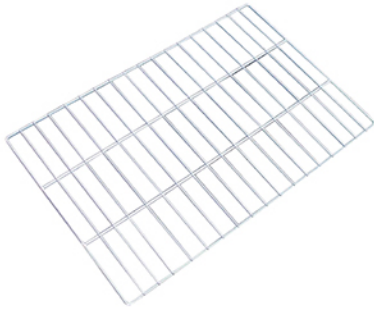

AC 5 Cooking Shelf

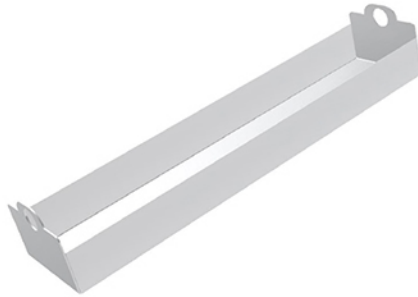

AC 9 Roasting Tin

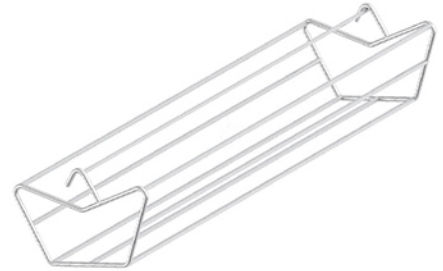

AC 11 Basket for Big Pieces

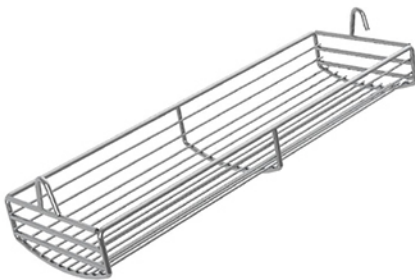

AC 12 Leg Basket



AC 45 Fork Spit for large Meat Pieces



AC 46 Tightening Spit for large Meat Pieces

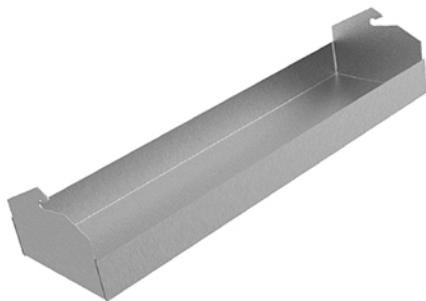

AC 26 Large Tray

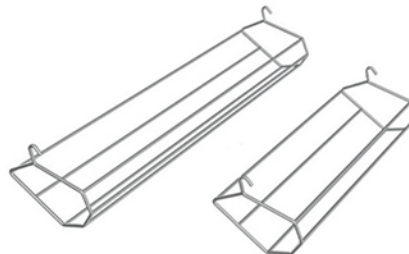

AC 28 Regular Basket

1515 Design & Manufacturing
405 N. Oak Street, Inglewood CA 90302
Toll free (888) 671 0360
Tel. (310) 671 0345
Fax (310) 680 2879
E-mail : info@1515design.com

1515 Design
& Manufacturing

WWW.1515DESIGN.COM

BASKET -ROAST ROTISSERIES ACCESSORIES

ACCESSORIES

Manufacturer :



Ventless Hood for
N1, N2, NEOL,
AC 30 STEAMBOX, NEOBOX



Ventless Hood
AC 31 for D-ONE

1515 Design & Manufacturing
405 N. Oak Street, Inglewood CA 90302
Toll free (888) 671 0360
Tel. (310) 671 0345
Fax (310) 680 2879
E-mail : info@1515design.com

1515 Design
& Manufacturing

WWW.1515DESIGN.COM

BASKET -ROAST ROTISSERIES ACCESSORIES

AC 5 STAINLESS STEEL COOKING SHELF

Manufacturer :



STAINLESS STEEL COOKING SHELF

Transforms your rotisserie into an oven for static cooking of quiches, pizzas, lasagna, dish of the day...

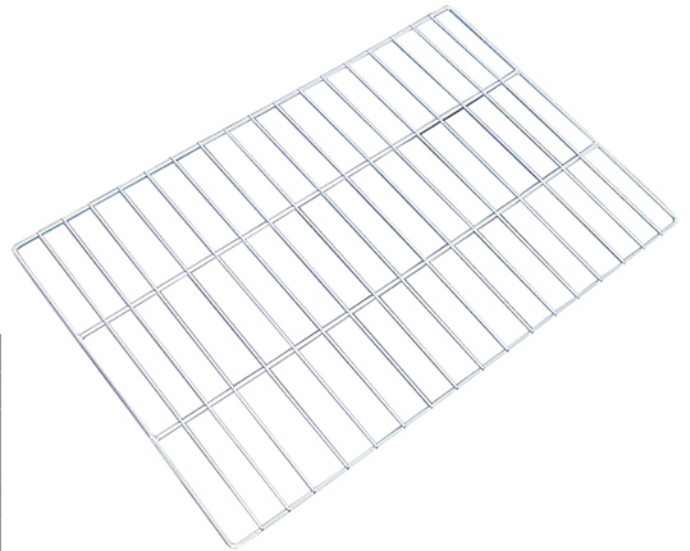

FEATURES

Model	Length	Width
AC00052		
RB 12 NE EN 1	20 3/4"	19"
AC00053		
RB 15 DECO EB 15 DECO NEOGRILL 1 STEAMBOX	22 1/2"	21 3/4"
AC00054		
RB 16 NE RB 24 NE NEOGRILL 2 SENSUP 6 ES 6	29 1/2"	19"
AC00057		
RB 20/30 DECO EB 20/30 DECO EN 2	25 1/4"	30 1/2"
AC00058		
SENSUP 9 ES 9	30 3/4"	29 1/2"
AC00164		
RB 48 NE EB 48 NE	33 1/2"	30 1/2"

BASKET -ROAST ROTISSERIES ACCESSORIES

AC 9- ROASTING TIN

Manufacturer :



ROASTING TIN

- Hollow stainless steel tray placed in the swing rotisserie for cooking products in sauce :
- Stuffed tomatoes
- Paupiettes
- Stuffed Zucchini
- Marinated meats
- Etc...

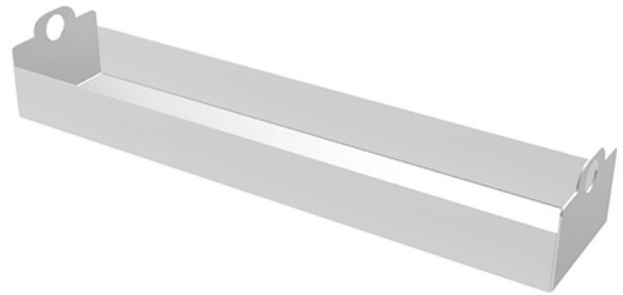

FEATURES SMALL MODEL

Modèle	AC00087		
	Length	Width	Height
NEOGRILL N1	18"	4"	1 3/4"
STEAMBOX	18"	4"	1 3/4"
RB 12 NE	18"	4"	1 3/4"
RB 15 DECO	18"	4"	1 3/4"
D-BOX	18"	4"	1 3/4"

FEATURES LARGE MODEL

Modèle	AC00088		
	Length	Width	Height
NEOGRILL N2	26 3/4"	4"	1 3/4"
SENSUP 6/9	26 3/4"	4"	1 3/4"
RB 16/24/48 NE	26 3/4"	4"	1 3/4"
RB 20/30 DECO	26 3/4"	4"	1 3/4"
D-ONE	26 3/4"	4"	1 3/4"



BASKET -ROAT ROTISSERIES ACCESSORIES

AC 11 - BASKET BIG PIECES

Manufacturer :



BASKET FOR BIG PIECES

Basket for large pieces for cooking capons, ducks, , very large chickens, ...

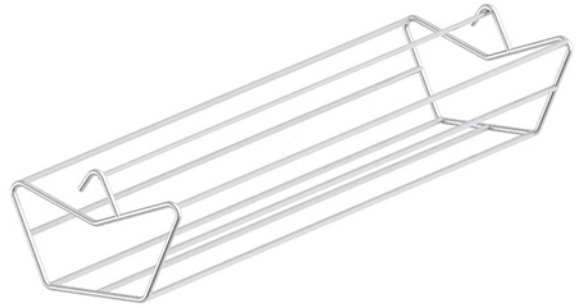

FEATURES SMALL MODEL

Modèle	AC00003		
	Longueur	Largeur	Hauteur
NEOGRILL N1	19 3/4"	6 3/4"	4"
STEAMBOX	19 3/4"	6 3/4"	4"
RB 12 NE	19 3/4"	6 3/4"	4"
RB 15 DECO	19 3/4"	6 3/4"	4"
D-BOX	19 3/4"	6 3/4"	4"

FEATURES LARGE MODEL

Modèle	AC00004		
	Longueur	Largeur	Hauteur
NEOGRILL N2	28 1/3"	6 3/4"	4"
SENSUP 6/9	28 1/3"	6 3/4"	4"
RB 16/24/48 NE	28 1/3"	6 3/4"	4"
RB 20/30 DECO	28 1/3"	6 3/4"	4"
D-ONE	28 1/3"	6 3/4"	4"

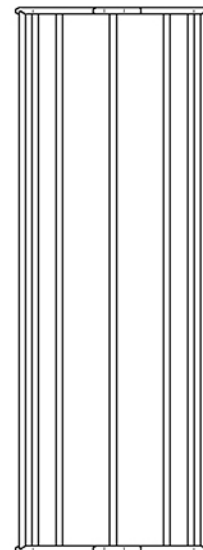

BASKET -ROAT ROTISSERIES ACCESSORIES

AC 12 - LEG BASKET

Manufacturer :



LEG BASKET

Basket to replace a classic basket for cooking:

- chicken legs :
- Grilled fish
- Fish filets
- Small cutouts
- Potatoes
- Stuffed vegetables
- Etc...

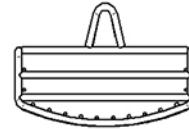
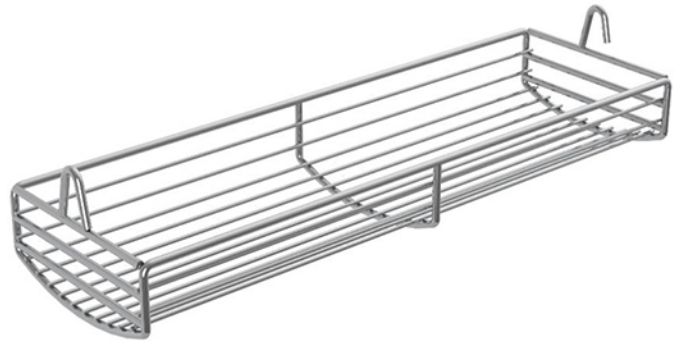

FEATURES SMALL MODEL

Modèle	AC00001		
	Length	Width	Height
NEOGRILL N1	19 3/4"	6 1/3"	4"
STEAMBOX	19 3/4"	6 1/3"	4"
RB 12 NE	19 3/4"	6 1/3"	4"
RB 15 DECO	19 3/4"	16 1/3"	4"
D-BOX	19 3/4"	6 1/3"	4"

FEATURES LARGE MODEL

Modèle	AC00002		
	Length	Width	Height
NEOGRILL N2	28 1/3"	6 1/3"	4"
SENSUP 6/9	28 1/3"	6 1/3"	4"
RB 16/24/48 NE	28 1/3"	6 1/3"	4"
RB 20/30 DECO	28 1/3"	6 1/3"	4"
D-ONE	28 1/3"	6 1/3"	4"

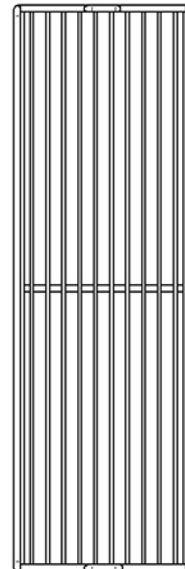

BASKET -ROAST ROTISSERIES ACCESSORIES

AC 45 - FORK SPIT

Manufacturer :



Large pieces spit for whole hams, suckling pigs, cherubs

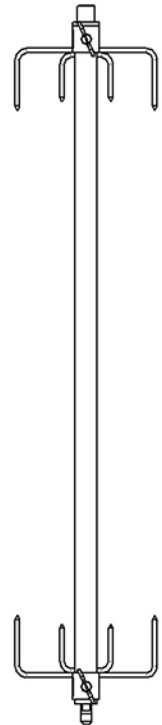
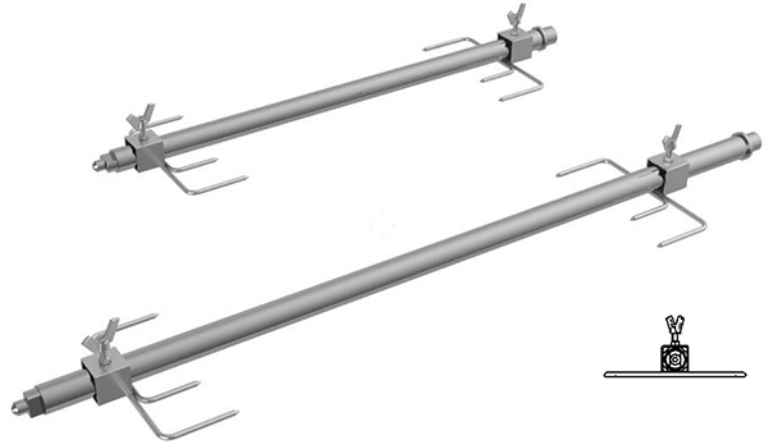

FEATURTES SMALL MODEL

Model	AC 17	
	Longueur	Largeur
NEOGRILL N1	19 1/3"	6 1/3"
STEAMBOX	19 1/3"	6 1/3"
RB 12 NE	19 1/3"	6 1/3"
RB 15 DECO	19 1/3"	6 1/3"
D-BOX	19 1/3"	6 1/3"

FEATURTES LARGE MODEL

Model	AC 17	
	Longueur	Largeur
NEOGRILL N2	27 1/2"	6 1/3"
SENSUP 6/9	27 1/2"	6 1/3"
RB 16/24/48 NE	27 1/2"	6 1/3"
RB 20/30 DECO	27 1/2"	6 1/3"
D-ONE	27 1/2"	6 1/3"

BASKET -ROAST ROTISSERIES ACCESSORIES

AC 46 - TIGHTENING SPIT

Manufacturer :



Large pieces spit for whole hams, suckling pigs, cherubs

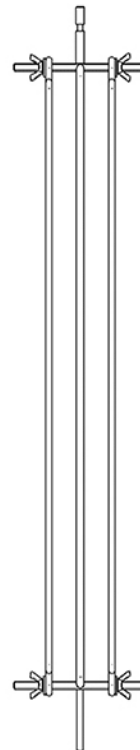
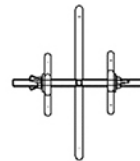
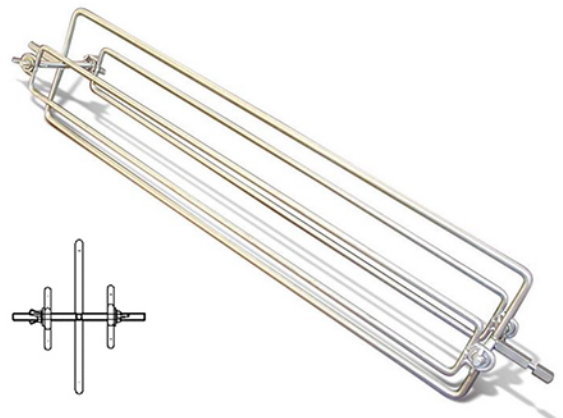

FEATURES

Model	Length	Width
D-ONE	29"	Forks
NANTAISE	26 1/3"	Forks
NEOGRILL N1	20 3/4"	9"
RB20	27 1/2"	7 3/4"
STEAMBOX	17 3/4"	Forks
SENSUP	27 1/2"	7 3/4"

BASKET -ROAT ROTISSERIES ACCESSORIES

AC 26 - LARGE CAPACITY TRAY

Manufacturer :



LARGE CAPACITY TIN

- Used for cooking potatoes, vegetables, stuffed tomatoes, etc...

- it replaces a classic basket.

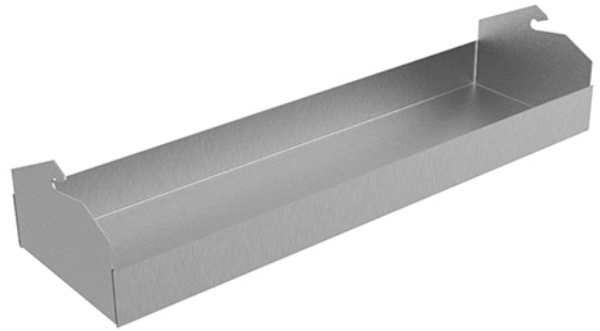

FEATURES SMALL MODEL

Model	AC00089		
	Length	Width	Height
NEOGRILL N1	19 3/4"	5 3/4"	1 3/4"
STEAMBOX	19 3/4"	5 3/4"	1 3/4"
RB 12 NE	19 3/4"	5 3/4"	1 3/4"
RB 15 DECO	19 3/4"	5 3/4"	1 3/4"
D-BOX	19 3/4"	5 3/4"	1 3/4"

FEATURES LARGE MODEL

Model	AC00090		
	Length	Width	Height
NEOGRILL N2	28 1/3"	5 3/4"	1 3/4"
SENSUP 6/9	28 1/3"	5 3/4"	1 3/4"
RB 16/24/48 NE	28 1/3"	5 3/4"	1 3/4"
RB 20/30 DECO	28 1/3"	5 3/4"	1 3/4"
D-ONE	28 1/3"	5 3/4"	1 3/4"



dorégrill
USA



1515Design

1515 Design & Manufacturing
405 N. Oak Street Inglewood, CA 90302 USA
Toll free: 888-671-0630 Tel: 310-671-0345 Fax: 310-680-2879
E-mail: contact@1515design.com www.1515design.com